

## Dual Transient Voltage Suppressors Array for ESD Protection

### General Description

The LGSOT05CLT1G is a dual monolithic voltage suppressor designed to protect components which are connected to data and transmission lines against ESD. It clamps the voltage just above the logic level supply for positive transients, and to a diode drop below ground for negative transients. It can also work as bidirectional suppressor by connecting only pin1 and 2.

## LGSOT05CLT1G

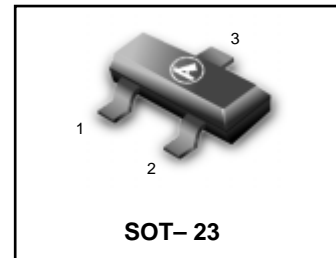

### Applications

- Computers
- Printers
- Communication systems

### Features

- 2 Unidirectional Transil functions
- Low leakage current:  $I_R \max < 20 \mu A$  at  $V_{RM}$
- 300W peak pulse power(8/20  $\mu s$ )
- Transient protection for data lines as per  
**IEC61000-4-2(ESD)** 15KV(air) 8KV(contact)  
**IEC61000-4-5(Lightning)** see  $I_{PPM}$  below

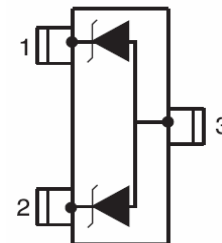

### ORDERING INFORMATION

Device	Package	Shipping
LGSOT05CLT1G	SOT-23	3000/Tape & Reel

Absolute Ratings ( $T_{amb}=25^{\circ}C$ )			
Symbol	Parameter	Value	Units
$P_{PP}$	Peak Pulse Power ( $t_p = 8/20\mu s$ )	300	W
$T_L$	Maximum lead temperature for soldering during 10s	260	$^{\circ}C$
$T_{stg}$	Storage Temperature Range	-55 to +15	$^{\circ}C$
$T_{op}$	Operating Temperature Range	-40 to +125	$^{\circ}C$
$T_j$	Maximum junction temperature	150	$^{\circ}C$
$V_{PP}$	Electrostatic discharge		
	IEC61000-4-2 air discharge	15	kv
	IEC61000-4-2 contact discharge	8	

# LGSOT05CLT1G

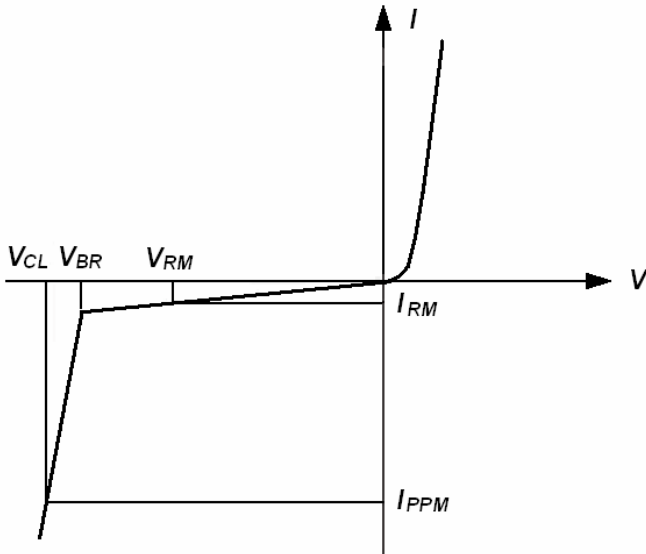

### Electrical Parameter

Symbol	Parameter
$V_{RM}$	Stand-off voltage
$V_{BR}$	Breakdown voltage
$V_{CL}$	Clamping voltage
$I_{RM}$	Leakage current
$I_{PPM}$	Peak pulse current

### Electrical Characteristics

Part Numbers	Rated Stand-off Voltage	Maximum Leakage Current	Minimum Breakdown Voltage	Maximum Clamping Voltage		Maximum Pulse Peak Current	Maximum Capacitance
		@ $V_{RM}$		1mA	1A <sup>1)</sup>		
	$V_{RM}$	$I_{RM}$	$V_{BR}$	$V_{CL}$		$I_{PPM}$	C
	V	$\mu A$	V	V	V	A	pF
LGSOT04CLT1G	4.0	20.0	5.0	8.5	10.5	17	300
LGSOT05CLT1G	5.0	20.0	6.0	9.8	12.5	17	220
LGSOT08CLT1G	8.0	5.0	8.5	13.4	15.0	15	190
LGSOT12CLT1G	12.0	1.0	13.3	19.0	28.0	12	90
LGSOT15CLT1G	15.0	1.0	16.7	24	39.0	10	60

1).8/20 waveform used. (see fig2.)

### Typical Characteristics

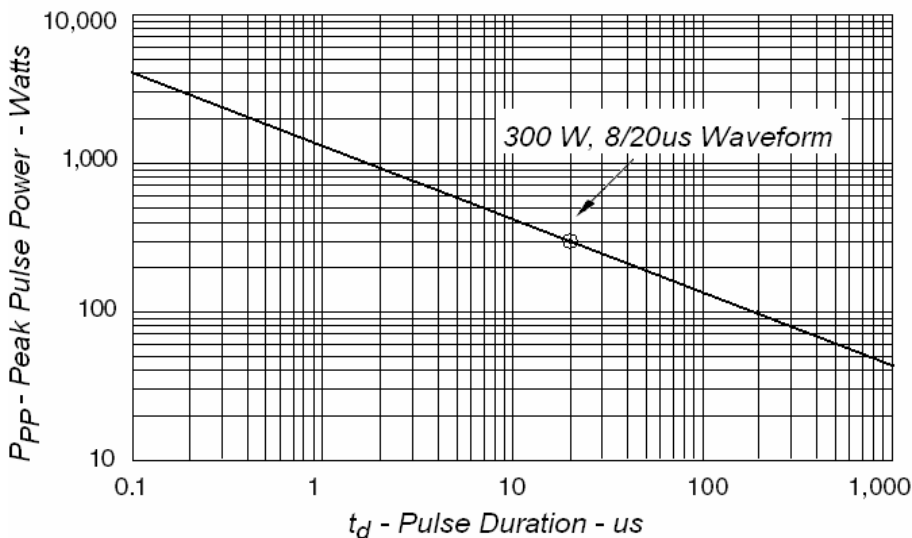
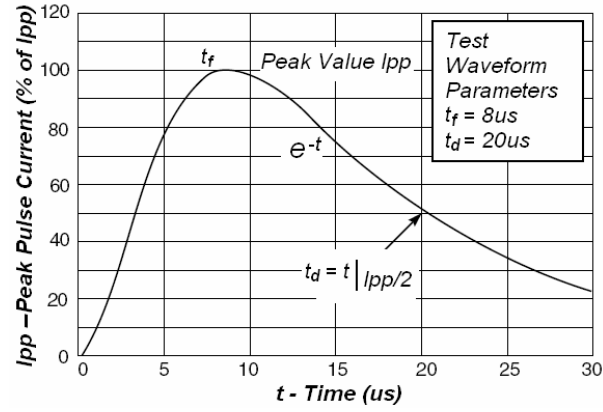
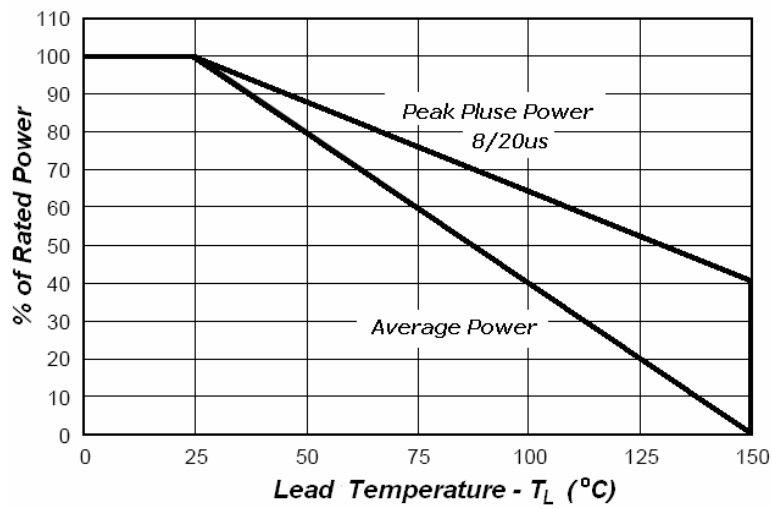

Fig1. Peak Pulse Power VS Pulse Time

# LGSOT05CLT1G



**Fig2. Pulse Waveform**



**Fig3. Power Derating**

# LGSOT05CLT1G

## Application Note

Electrostatic discharge (ESD) is a major cause of failure in electronic systems. Transient Voltage Suppressors (TVS) are an ideal choice for ESD protection. They are capable of clamping the incoming transient to a low enough level such that damage to the protected semiconductor is prevented.

Surface mount TVS arrays offer the best choice for minimal lead inductance. They serve as parallel protection elements, connected between the signal line to ground. As the transient rises above the operating voltage of the device, the TVS array becomes a low impedance path diverting the transient current to ground. The LGSOT05CLT1G array is the ideal board level protection of ESD sensitive semiconductor components.

The tiny SOT23 package allows design flexibility in the design of high density boards where the space saving is at a premium. This enables to shorten the routing and contributes to hardening against ESD.

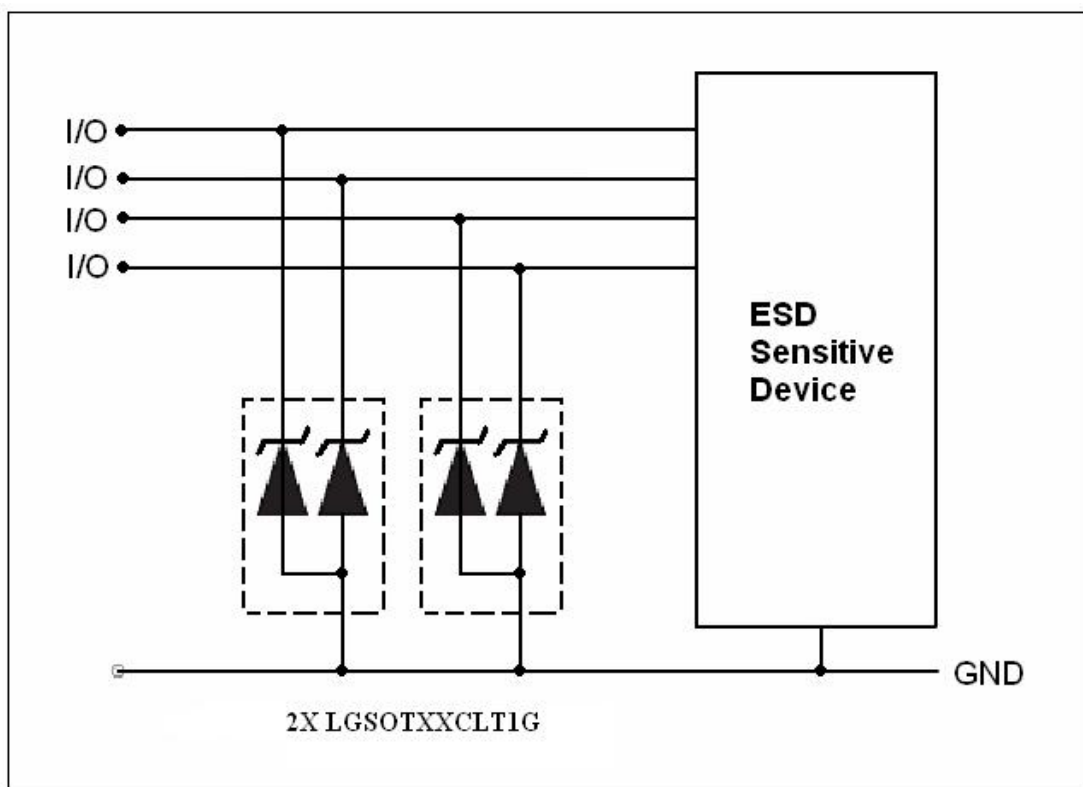

# LGSOT05CLT1G

## SOT-23

NOTES:

1. DIMENSIONING AND TOLERANCING PER ANSI Y14.5M,1982
2. CONTROLLING DIMENSION: INCH.

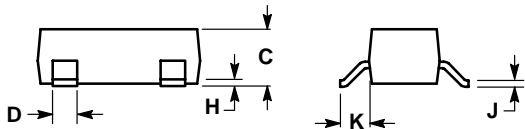
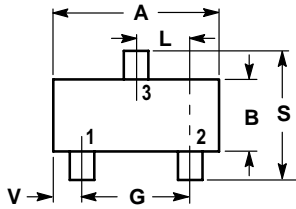

DIM	INCHES		MILLIMETERS	
	MIN	MAX	MIN	MAX
A	0.1102	0.1197	2.80	3.04
B	0.0472	0.0551	1.20	1.40
C	0.0350	0.0440	0.89	1.11
D	0.0150	0.0200	0.37	0.50
G	0.0701	0.0807	1.78	2.04
H	0.0005	0.0040	0.013	0.100
J	0.0034	0.0070	0.085	0.177
K	0.0140	0.0285	0.35	0.69
L	0.0350	0.0401	0.89	1.02
S	0.0830	0.1039	2.10	2.64
V	0.0177	0.0236	0.45	0.60

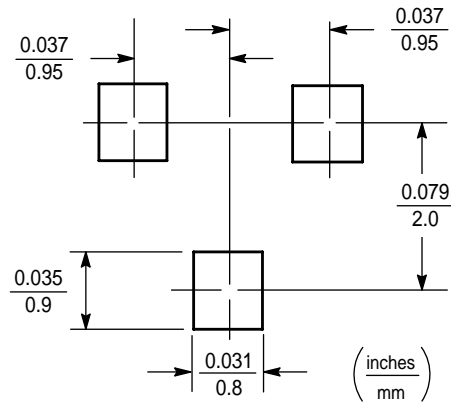

## EMBOSSED TAPE AND REEL DATA FOR DISCRETES

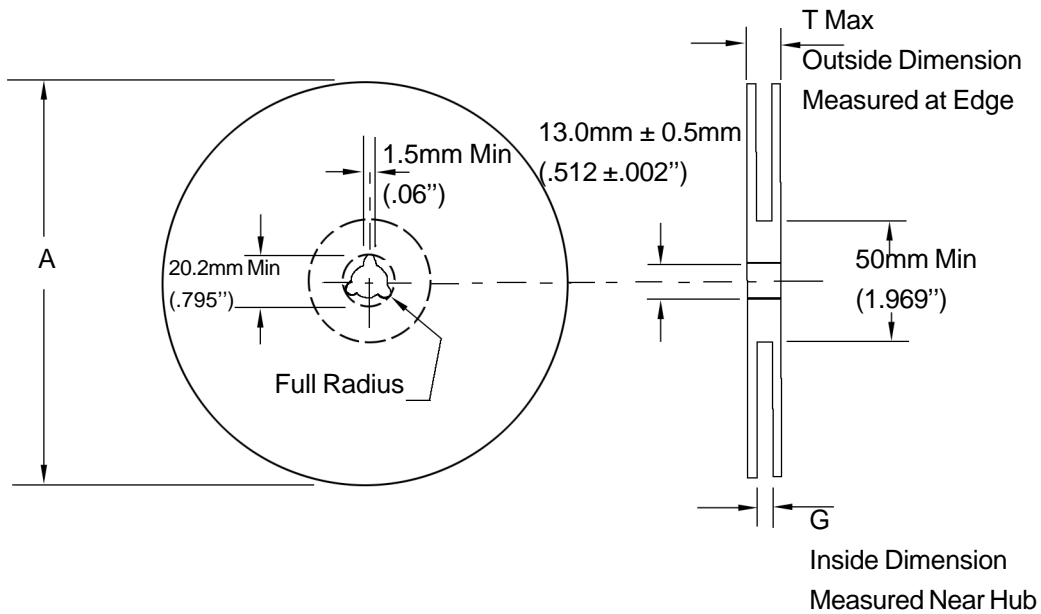

Size	A Max	G	T Max
8 mm	330mm (12.992")	8.4mm+1.5mm, -0.0 (.33"+.059", -0.00)	14.4mm (.56")

### Reel Dimensions

Metric Dimensions Govern — English are in parentheses for reference only

#### Storage Conditions

Temperature: 5 to 40 Deg.C (20 to 30 Deg. C is preferred)

Humidity: 30 to 80 RH (40 to 60 is preferred)

Recommended Period: One year after manufacturing

(This recommended period is for the soldering condition only. The characteristics and reliabilities of the products are not restricted to this limitation)

## Shipment Specification

